

GB-52-4 SERIES
4 Across
Bi-Level (18.0 x 9.6 x 8.2mm)

MAIN FEATURES:

- Low Power Consumption
- High Efficiency and Low Cost
- Good Control and Free Combinations on The Colors of LED Lamps
- Good Lock and Easy To Assembly

ABSOLUTE MAXIMUM RATINGS: (Ta=25°C)

Reverse Voltage	GaASP Red 3.0V Other 5.0V
D.C. Forward Current	30mA
Plus Current (1/10 Duty Cycle 0.1mS Plus Width)	100mA
Operating Temperature Range	- 40°C To + 80°C
Storage Temperature Range	- 40°C To + 80°C
Lead Soldering Temp (1.6mm Form Body)	260°C For 5 Sec.

- NOTES: 1. All Dimensions ±0.25mm Unless Otherwise Noted.
2. Color Combination As Customer's Requirement.
3. Holder Color: Black
4. Holder Material Meets UI94V-2*

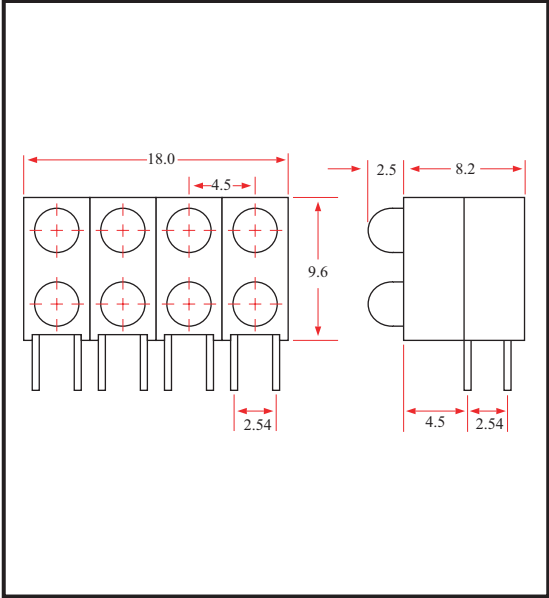
PACKAGE DIMENSIONS

PART NO. SELECTION AND APPLICATION INFORMATION (RATINGS AT 25°C AMBIENT)

Part No.	Emitted Color	Lens Color	Peak Wavelength @ 20mA (nm)	Forward Voltage @ 20mA Typ.	Luminous Intensity @ 20mA (mcd)	View Angle 2θ _{1/2} (Deg)
GB-52-4-II	Hi-Eff Red	Red Diffused	635	2.1	40	50
GB-52-4-YY	Yellow	Yellow Diffused	588	2.1	35	50
GB-52-4-GG	Green	Green Diffused	568	2.2	50	50
GB-52-4-IG	Hi-Eff Red / Green	Red / Green Diffused	635 / 568	2.1 / 2.2	100 / 50	50 / 50
GB-52-4-YG	Yellow / Green	Yellow / Green Diffused	588 / 568	2.1 / 2.2	40 / 50	50 / 50

TESTING CONDITION FOR EACH PARAMETER :

PARAMETER:	SYMBOL	UNIT	TEST CONDITION
REVERSE VOLTAGE	Vr	VOLT	Vr = 5.0 Volt
REVERSE CURRENT	Ir	μA	If = 20mA
FORWARD VOLTAGE	Vf	VOLT	If = 20mA
LUMINOUS INTENSITY	Iv	MCD	If = 20mA
VIEWING ANGLE	2θ _{1/2}	DEGREE	
RECOMMENDED OPERATING CURRENT	If (Rec)	mA	